

Data Sheet



Article number: 021500700090

Description: Sealing Clamp S 90 W5

Measures

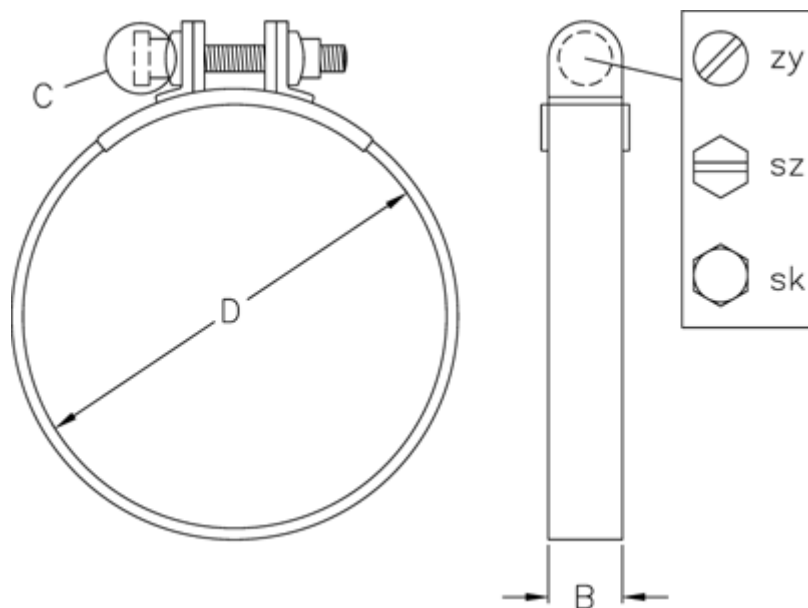

C (screw type) = SZ

Diameter D = 90

Width B = 20